



X

Y

Z

5V-os táp. pl. USB, külső táp, számítógép 5V

Számítógép LPT1 port
centronics 36

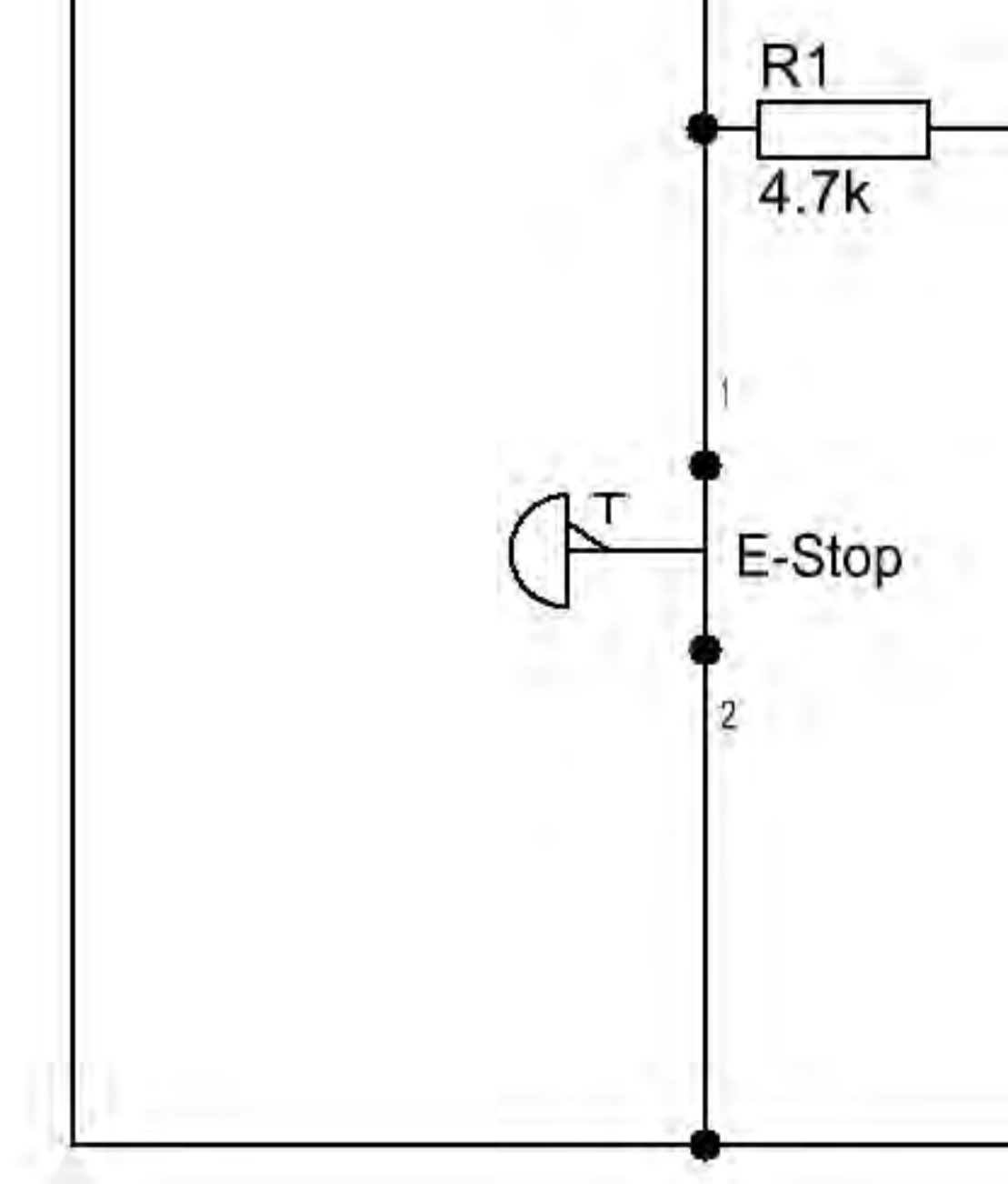
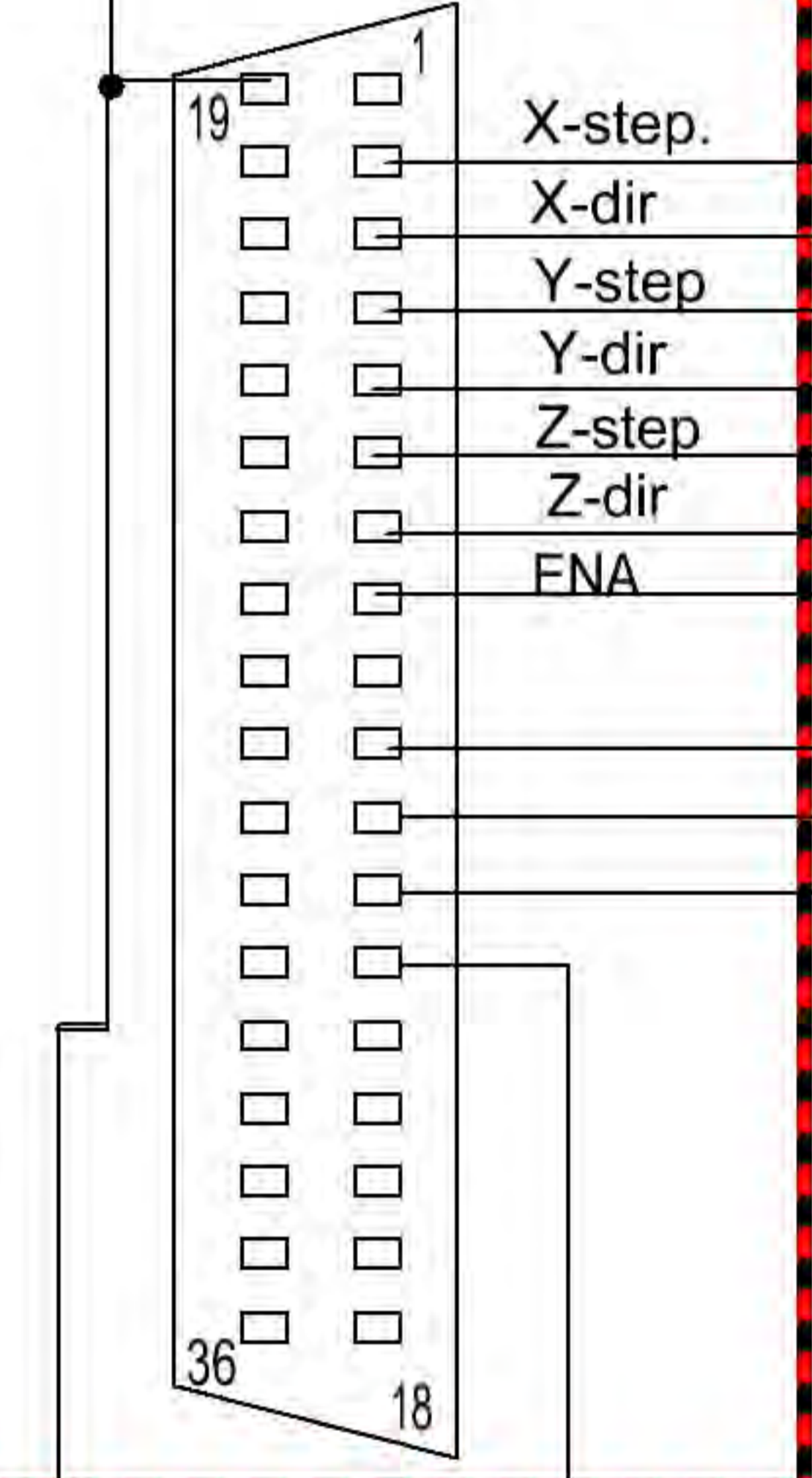

MSD-40-3.2

MSD-40-3.2

MSD-40-3.2

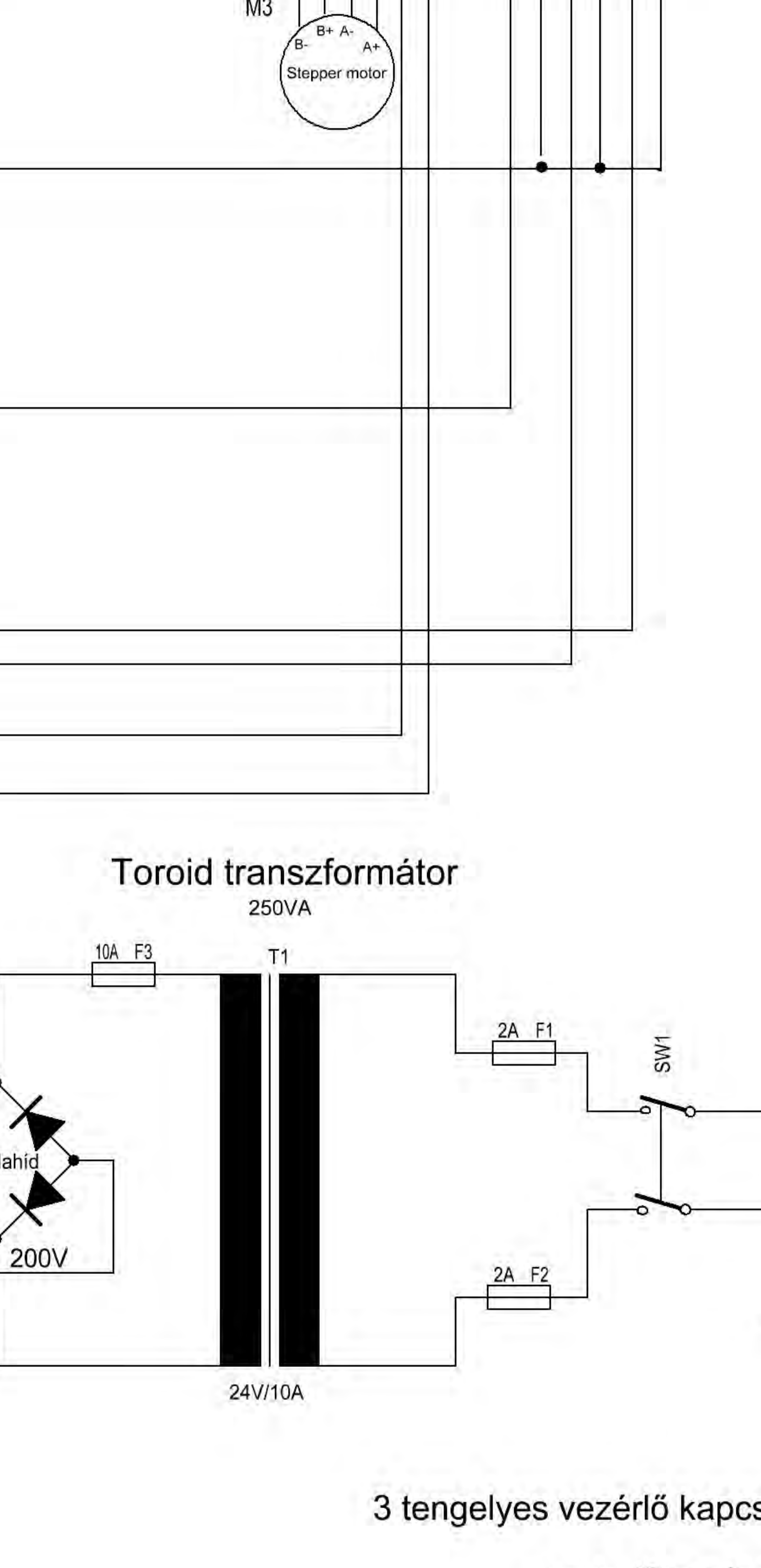
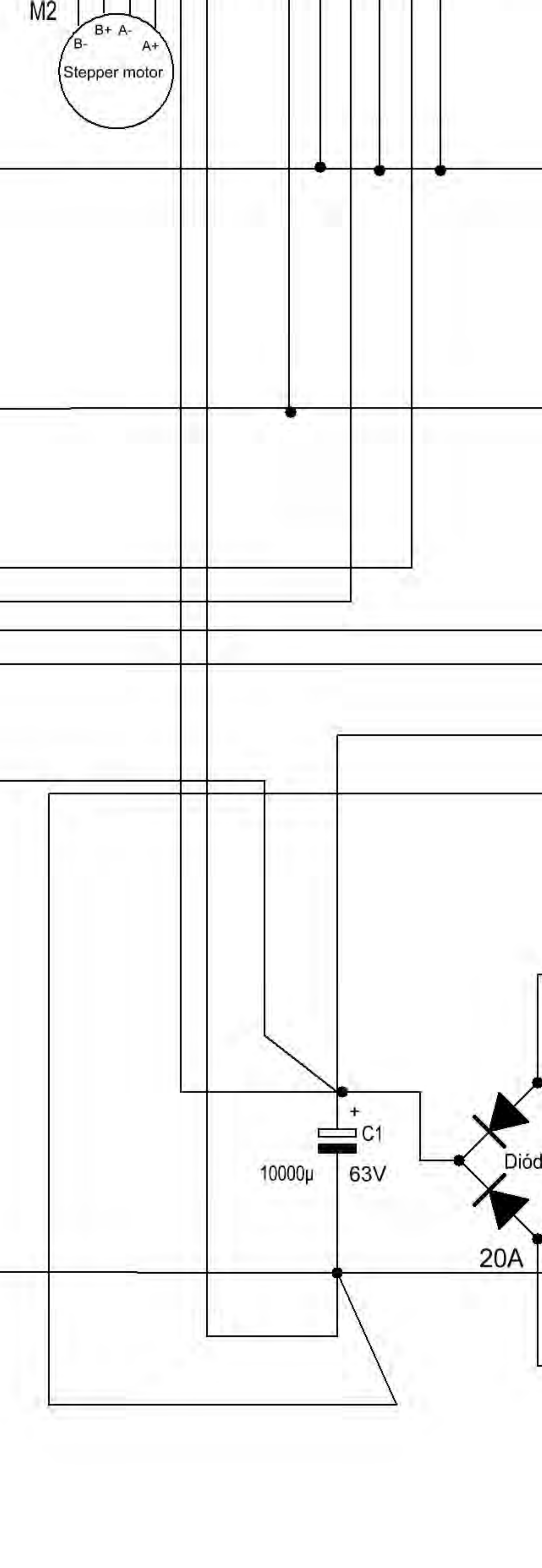
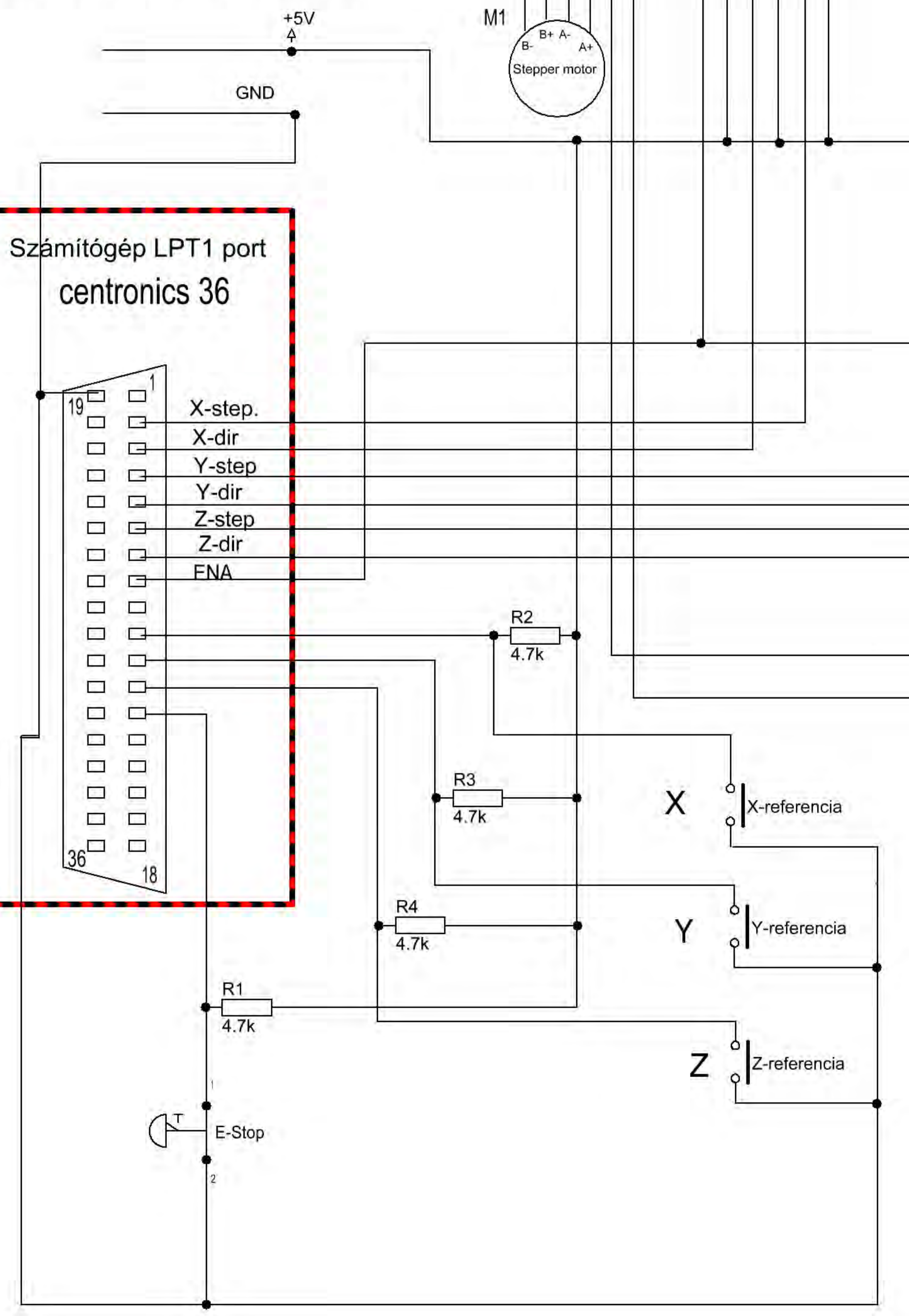
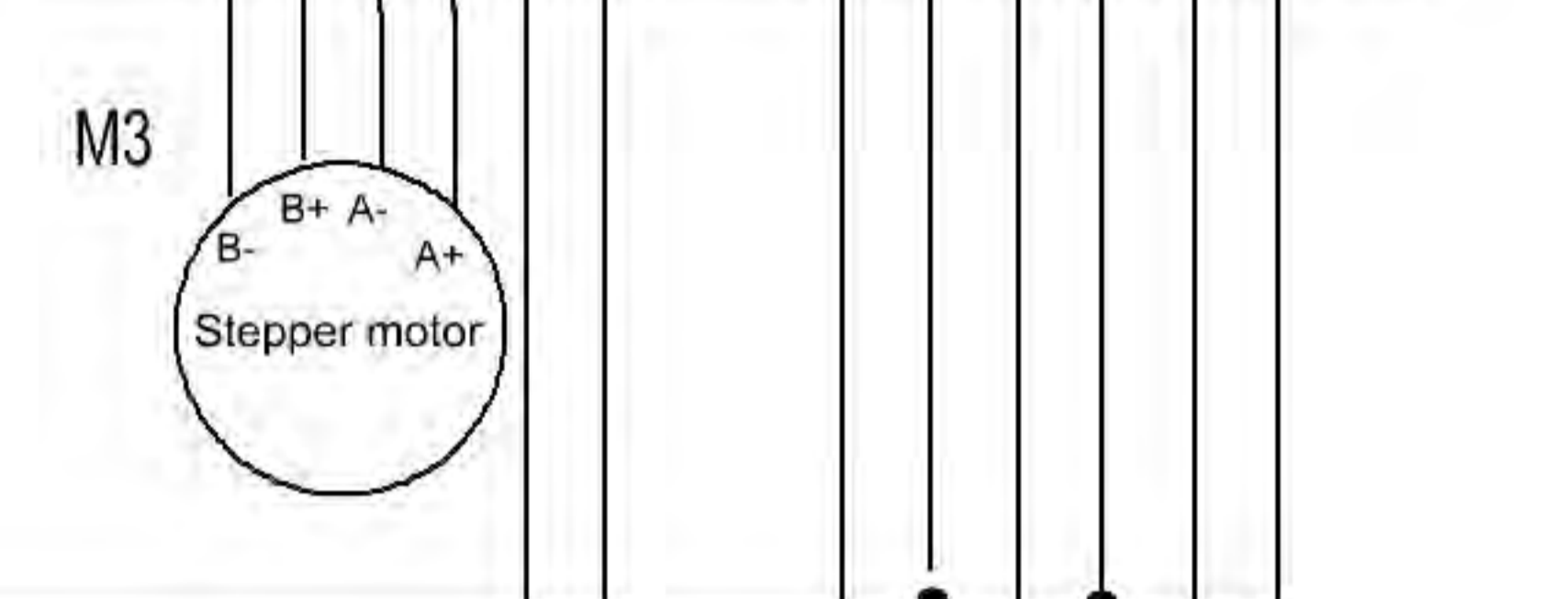
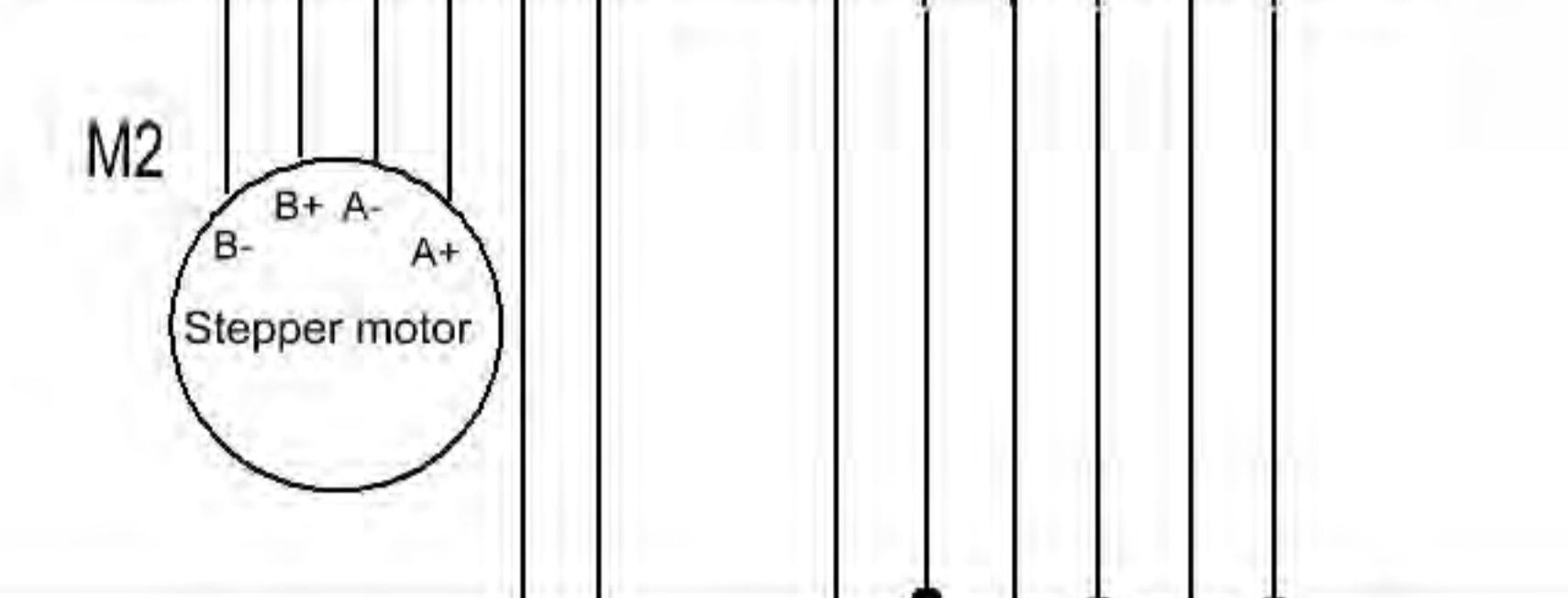
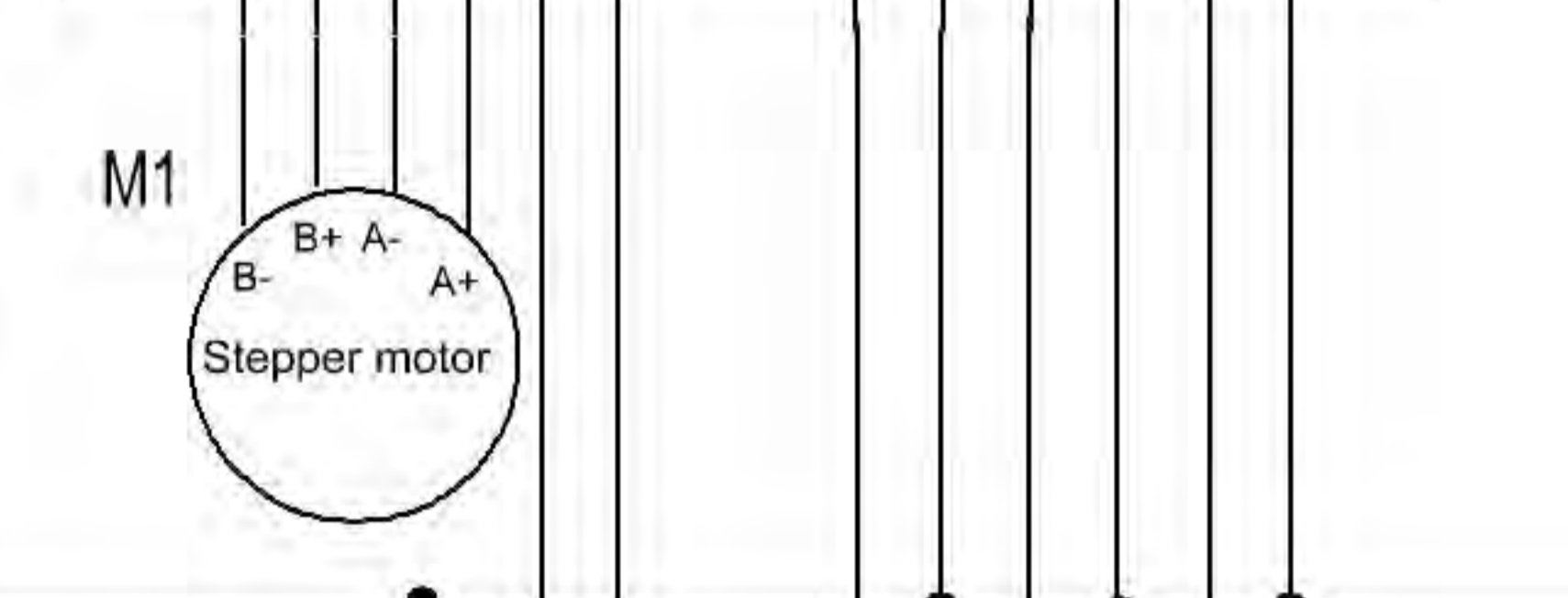
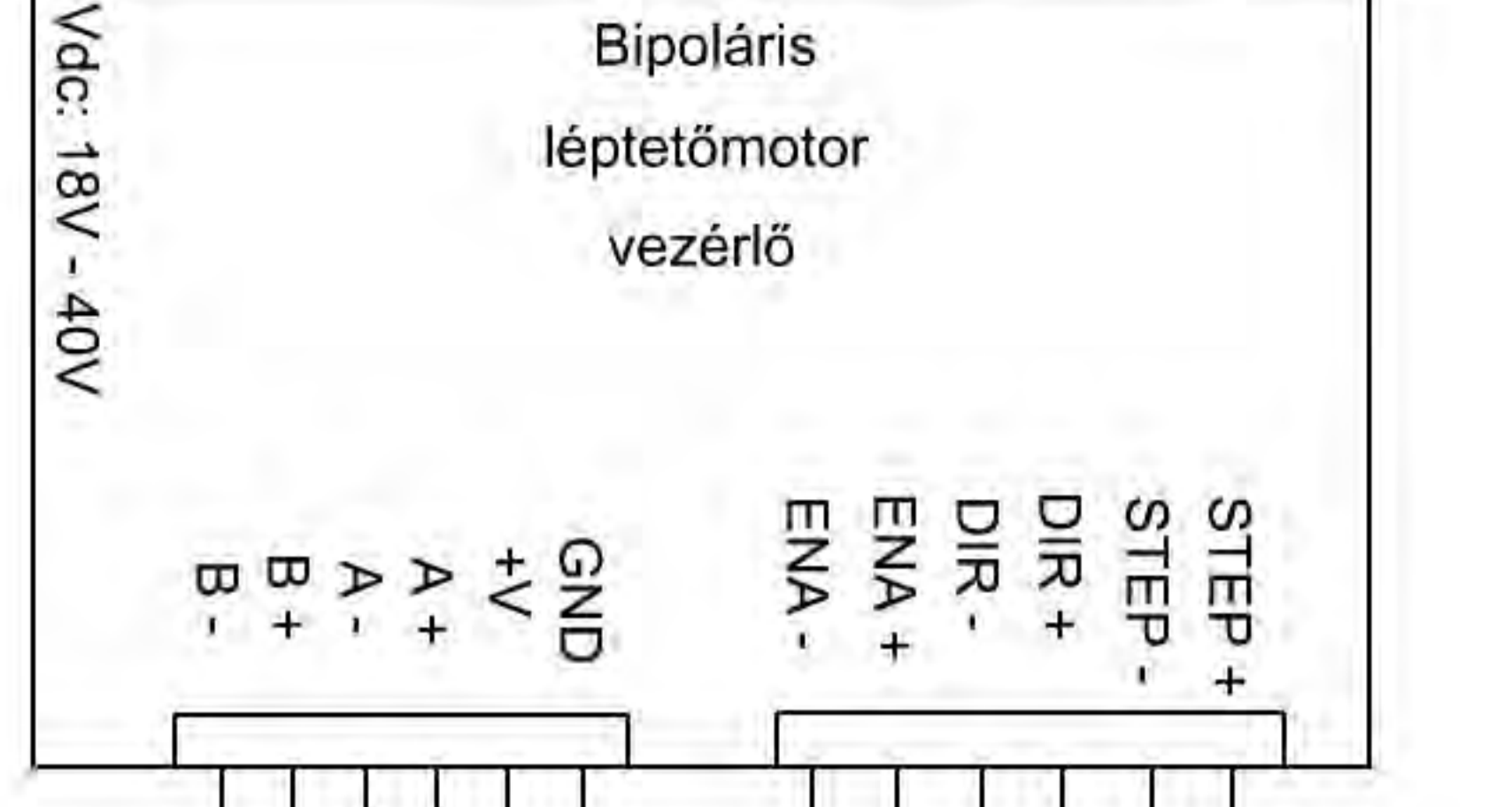
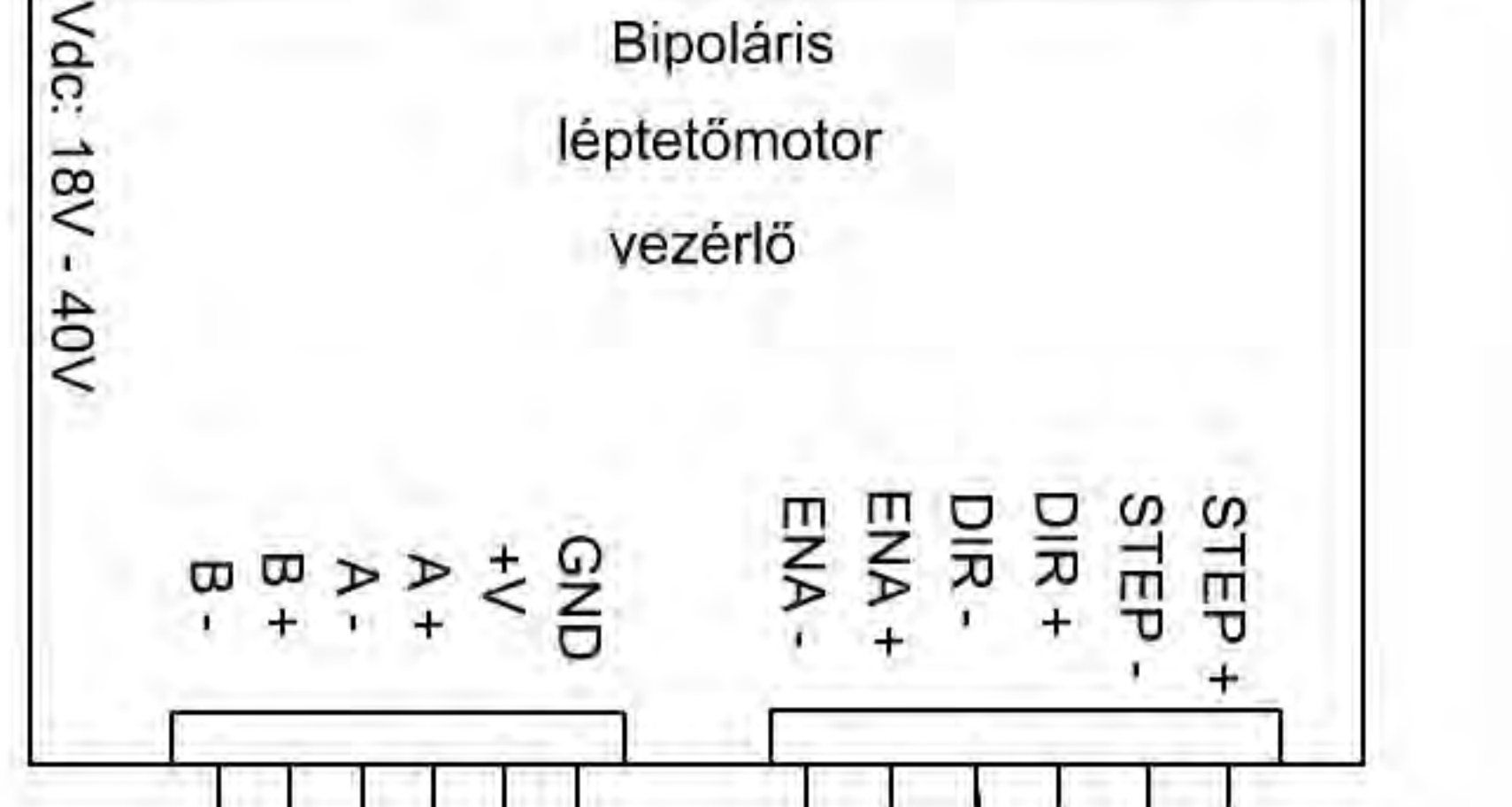
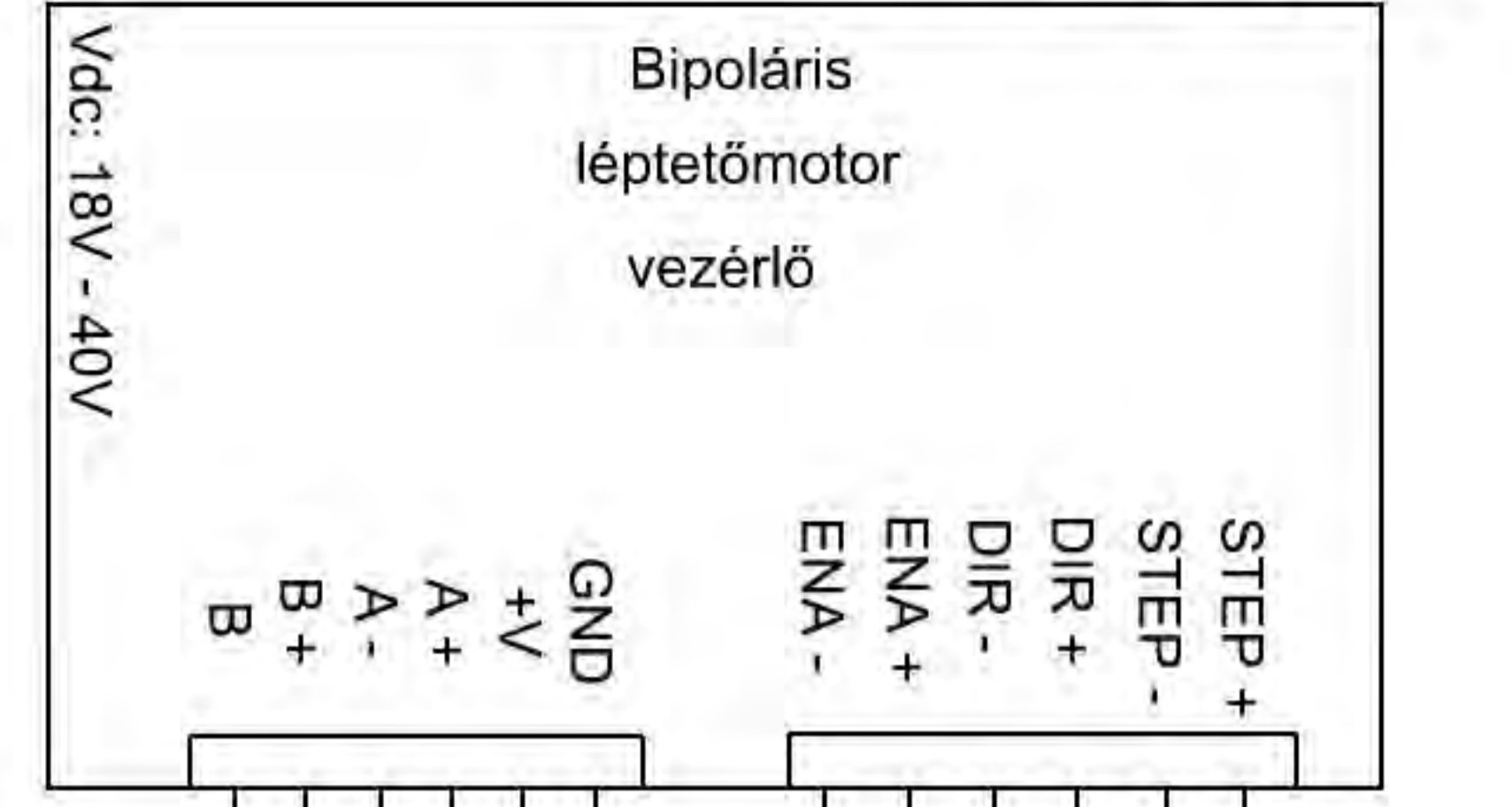

Toroid transzformátor
250VA

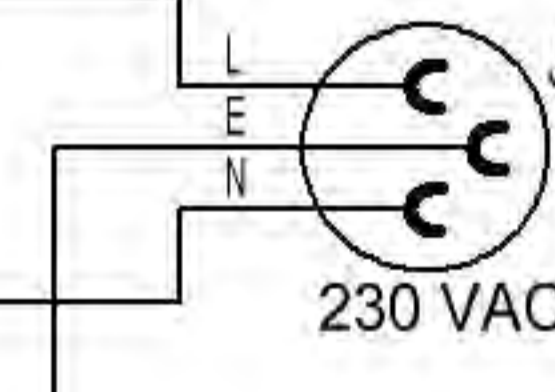
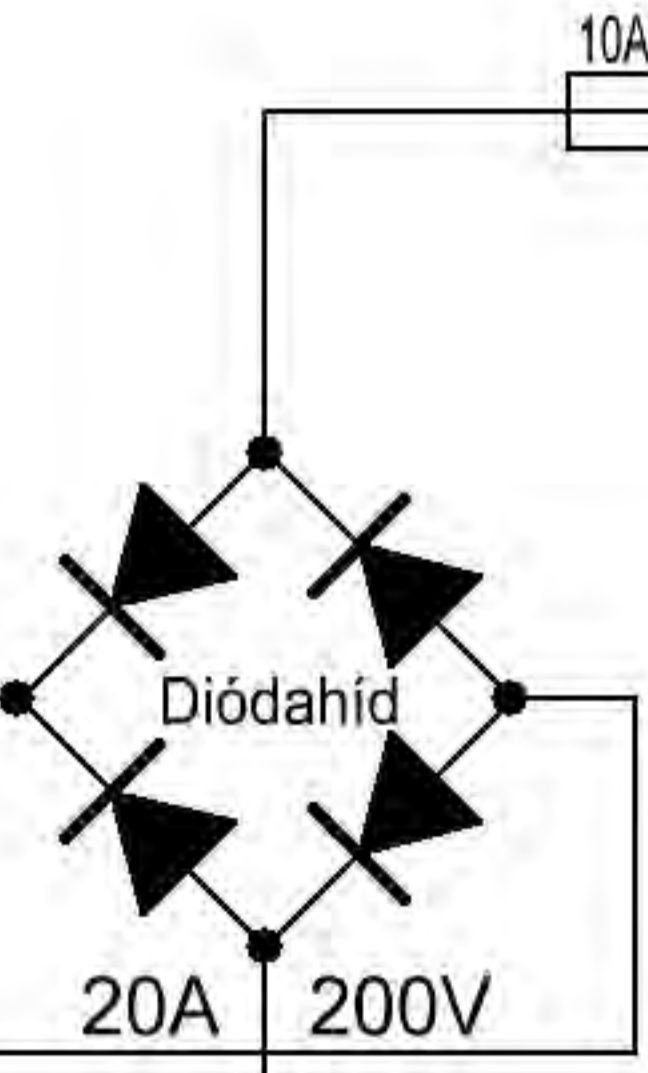

3 tengelyes vezérlő kapcsolási rajza